

**Agilent U1731B/U1732B  
Dual Display Handheld  
LCR Meter**

**User's and Service Guide**



**Agilent Technologies**

# Notices

© Agilent Technologies, Inc. 2009

No part of this manual may be reproduced in any form or by any means (including electronic storage and retrieval or translation into a foreign language) without prior agreement and written consent from Agilent Technologies, Inc. as governed by United States and international copyright laws.

## Manual Part Number

U1731-90059

## Edition

First Edition, December 1, 2009

Printed in Malaysia

Agilent Technologies, Inc.  
5301 Stevens Creek Blvd.  
Santa Clara, CA 95051 USA

## Warranty

**The material contained in this document is provided “as is,” and is subject to being changed, without notice, in future editions. Further, to the maximum extent permitted by applicable law, Agilent disclaims all warranties, either express or implied, with regard to this manual and any information contained herein, including but not limited to the implied warranties of merchantability and fitness for a particular purpose. Agilent shall not be liable for errors or for incidental or consequential damages in connection with the furnishing, use, or performance of this document or of any information contained herein. Should Agilent and the user have a separate written agreement with warranty terms covering the material in this document that conflict with these terms, the warranty terms in the separate agreement shall control.**

## Technology Licenses

The hardware and/or software described in this document are furnished under a license and may be used or copied only in accordance with the terms of such license.

## Restricted Rights Legend

U.S. Government Restricted Rights. Software and technical data rights granted to the federal government include only those rights customarily provided to end user customers. Agilent provides this customary commercial license in Software and technical data pursuant to FAR 12.211 (Technical Data) and 12.212 (Computer Software) and, for the Department of Defense, DFARS 252.227-7015 (Technical Data - Commercial Items) and DFARS 227.7202-3 (Rights in Commercial Computer Software or Computer Software Documentation).

## Safety Notices

### CAUTION

A **CAUTION** notice denotes a hazard. It calls attention to an operating procedure, practice, or the like that, if not correctly performed or adhered to, could result in damage to the product or loss of important data. Do not proceed beyond a **CAUTION** notice until the indicated conditions are fully understood and met.

---

















### WARNING

A **WARNING** notice denotes a hazard. It calls attention to an operating procedure, practice, or the like that, if not correctly performed or adhered to, could result in personal injury or death. Do not proceed beyond a **WARNING** notice until the indicated conditions are fully understood and met.



---

## Safety Symbols

The following symbols on the instrument and in the documentation indicate precautions that must be taken to maintain safe operation of the instrument.

	Direct current		Off (supply)
	Alternating current		On (supply)
	Both direct and alternating current		Equipment protected throughout by double insulation or reinforced insulation.
	Three-phase alternating current		Caution: risk of electric shock.
	Earth (ground) terminal		Caution: risk of danger (refer to this manual for specific Warning or Caution information).
	Protective conductor terminal		Caution: hot surface.
	Frame or chassis terminal		Out position of a bi-stable push control.
	Equipotentiality		In position of a bi-stable push control.

## Regulatory Markings

	<p>The CE mark is a registered trademark of the European Community. This CE mark shows that the product complies with all the relevant European Legal Directives.</p>		<p>The C-tick mark is a registered trademark of the Spectrum Management Agency of Australia. This signifies compliance with the Australia EMC Framework regulations under the terms of the Radio Communication Act of 1992.</p>
<p><b>ICES/NMB-001</b></p>	<p>ICES/NMB-001 indicates that this ISM device complies with Canadian ICES-001.</p>		<p>This instrument complies with the WEEE Directive (2002/96/EC) marking requirement. This affixed product label indicates that you must not discard this electrical/electronic product in domestic household waste.</p>

## Waste Electrical and Electronic Equipment (WEEE) Directive 2002/96/EC



This instrument complies with the WEEE Directive (2002/96/EC) marking requirement. This affixed product label indicates that you must not discard this electrical/electronic product in domestic household waste.

Product Category:

With reference to the equipment types in the WEEE directive Annex 1, this instrument is classified as a “Monitoring and Control Instrument” product. The affixed product label is shown as below:

### **Do not dispose in domestic household waste**

To return this unwanted instrument, contact your nearest Agilent office, or visit:

[www.agilent.com/environment/product](http://www.agilent.com/environment/product)

for more information.

## General Safety Information

The following general safety precautions must be observed during all phases of operation, service, and repair of this instrument. Failure to comply with these precautions or with specific warnings elsewhere in this manual violates safety standards for design, manufacture, and intended use of the instrument. Agilent Technologies assumes no liability for the customer's failure to comply with these requirements.

### WARNING

- **This meter is for indoor use at an altitude of up to 2,000 m.**
  - **The warnings and precautions should be read and well understood before the meter is used.**
  - **Use this meter only as specified in this manual; otherwise, the protection provided by the meter may be impaired.**
  - **When measuring in-circuit components, first de-energize the circuits before connecting them to the test leads.**
  - **Discharge the capacitor before testing.**
  - **The meter is safety-certified in compliance with IEC 61010-1.**
  - **Use the meter only as specified in this manual. Otherwise, the protection provided by the meter may be impaired.**
  - **The power for the meter is supplied with a single standard 9 V battery. Line operation is also possible using a 12 VAC to DC adaptor. If a power adaptor is selected, please be sure to meet the safety requirements of a relevant IEC standard.**
- 

### CAUTION

- **Ensure proper insertion of the battery in the LCR meter, and follow the correct polarity.**
-

## Environmental Conditions

This instrument is designed for indoor use in areas with low condensation and to be used with standard or compatible test probes. Table 1 shows general environment requirements.

**Table 1** Environment requirements

<b>Environment Conditions</b>	<b>Requirements</b>
Operating environment	0 °C to 40 °C; 0 – 70% R.H.
Storage humidity	0 – 80% R.H. non condensing
Storage environment	–20 °C to +50 °C; 0 – 80% R.H.
Altitude	0 – 2,000 meters
Pollution degree	Pollution degree 2

**CAUTION**

The U1731B/U1732B dual display handheld LCR meter complies with the following safety and EMC requirements:

- IEC 61010-1:2001/EN 61010-1:2001 (2nd Edition)
  - CISPR 11:2003+A1:2004
  - IEC 61000-4-2:1995+A1:1998 +A2:2000
  - IEC 61000-4-3:2006
  - IEC 61000-4-4:2004
  - IEC 61000-4-5:2005
  - IEC 61000-4-6:2003+A1:2004+A2:2006
  - IEC 61000-4-11:2004
  - Canada: ICES/NMB-001:2004
  - Australia/New Zealand: AS/NZS CISPR11:2004
- 

**CAUTION**

Degradation of some product specifications can occur in the presence of ambient electromagnetic (EM) fields and noise that affects the product's power line, communication, or I/O cables. The product self-recovers and operates to all specifications when:

- the source of the ambient EM field and noise is removed,
  - the product is protected from the ambient EM field, or
  - the product cabling is shielded from the ambient EM noise.
-

## Declaration of Conformity (DoC)

The Declaration of Conformity (DoC) for this instrument is available on the Web site. You can search the DoC by its product model or description.

<http://regulations.corporate.agilent.com/DoC/search.htm>

### NOTE

If you are unable to search for the respective DoC, please contact your local Agilent representative.

---



## In This Guide...

- 1 Getting Started** Chapter 1 introduces key features and steps to get started with a U1731B/U1732B dual display handheld LCR meter. This chapter also guides you through the basics of the front panel operations.
- 2 Features and Functions** Chapter 2 explains how to set up connections to perform meter measurements. It also describes the features and functions that are available in the U1731B/U1732B dual display handheld LCR meter in step-by-step instructions.
- 3 Service and Maintenance** Chapter 3 explains the services and maintenance procedures for the U1731B/U1732B dual display handheld LCR meter.
- 4 Specifications** Chapter 4 lists the specifications and characteristics of the U1731B/U1732B dual display handheld LCR meter.



# Contents

## 1 Getting Started

- Introduction 2
- Checking the Shipping Contents 3
- The Front Panel at a Glance 4
- Display Annunciators 5
- The Keypad at a Glance 7
- The Input Terminal at a Glance 8

## 2 Features and Functions

- Inductance Measurement 10
- Capacitance Measurement 11
- Resistance Measurement 12
- Data Hold 13
- Static Recording 13
- Dissipation Factor/Quality Factor/Phase Angle 13
- Test Frequency 14
- LCR Function Selector 14
  - Relative 14
  - Tolerance 15
  - Auto/Manual Range 15
  - Automatic Fuse Detection 16
  - Parallel/Series Mode 16
  - Calibration 17
  - Enable/Disable Auto Power-Off 18
  - Low Battery Indication 18
  - Backlit Display (Only Available for U1732B) 18
  - Communication (Optional Accessories) 19

## 3 Service and Maintenance

- Service 22
- Battery Replacement 22

## Contents

Fuse Replacement	24
Replacement Parts	25
Cleaning the LCR Meter	26
Specification Validation	27

### 4 Specifications

U1731B Electrical Specifications	30
U1732B Electrical Specifications	33
General Specifications	37
SMD Tweezers Specifications	39



# 1 Getting Started

Introduction	2
Checking the Shipping Contents	3
The Front Panel at a Glance	4
Display Annunciators	5
The Keypad at a Glance	7
The Input Terminal at a Glance	8

This chapter introduces the key features and getting-started tips for the U1731B/U1732B dual display handheld LCR meter. This chapter also guides you through the basics of the front panel operations.



## Introduction

The 20,000-count dual display handheld LCR meters (U1731B and U1732B) are special microprocessor-controlled meters for inductance, capacitance, and resistance measurements. The LCR meter is simple to operate and is capable of making absolute parallel mode measurements as well as series mode measurement. The LCR meter provides direct and accurate measurements of inductors, capacitors, and resistors with different testing frequencies. It offers both automatic and manual range selection.

The front panel keypad makes it convenient to select features and functions such as data hold, maximum, minimum, and average record mode, relative mode, tolerance sorting mode, frequency selection, and LCR selection. The test data can be transferred to a PC via an optional full isolated optical IR-USB interface. The U1732B offers backlight display capability for better visibility in the dark.

A tilt stand gives you flexibility in positioning the LCR meter for viewing and operating. The over-molding rubber case protects the LCR meter. Single 9 V battery operation is standard for the LCR meter, but a DC 12 V power adaptor can also be used as a power input.

## Checking the Shipping Contents

Inspect and verify that you have received the following items for the standard purchase of the U1731B/U1732B and/or accessories that you may have ordered. If any of the item listed below are missing, contact your nearest Agilent Technologies sales office.

**Table 1-1** List of standard and optional accessories

Type	Part Number	Accessories
Standard		Agilent U1731B/U1732B Quick Start Guide
		Alligator clip leads
		9 V Alkaline battery
		Certificate of Calibration (CoC)
Optional	U5481A	IR to USB cable
	U1780A	Power adaptor
	U1782A	SMD tweezers
	U1174A	Soft carrying case

## The Front Panel at a Glance

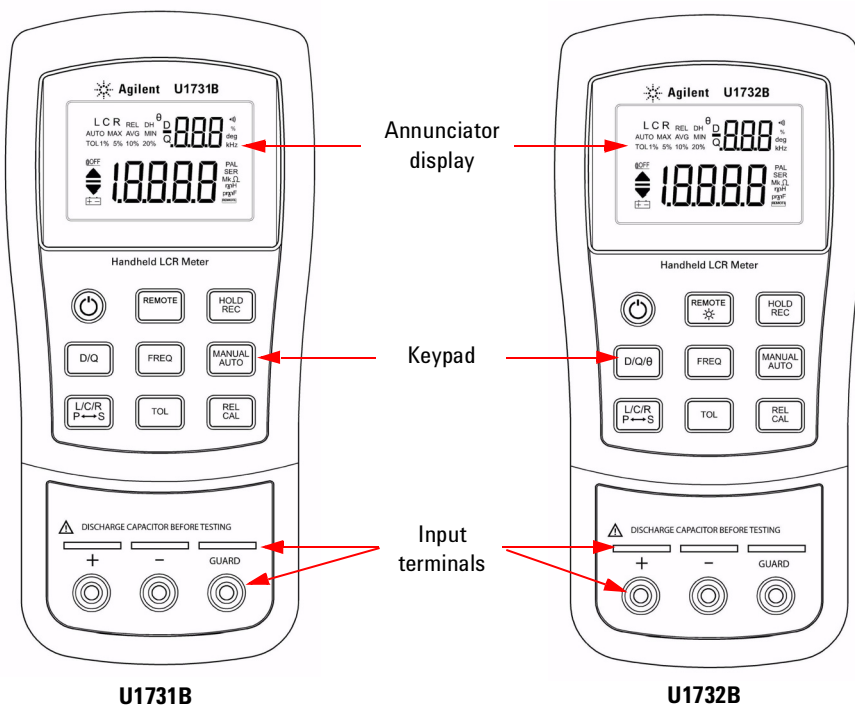

**Figure 1-1** Front panel of U1731B and U1732B dual display handheld LCR meter



## Display Annunciators

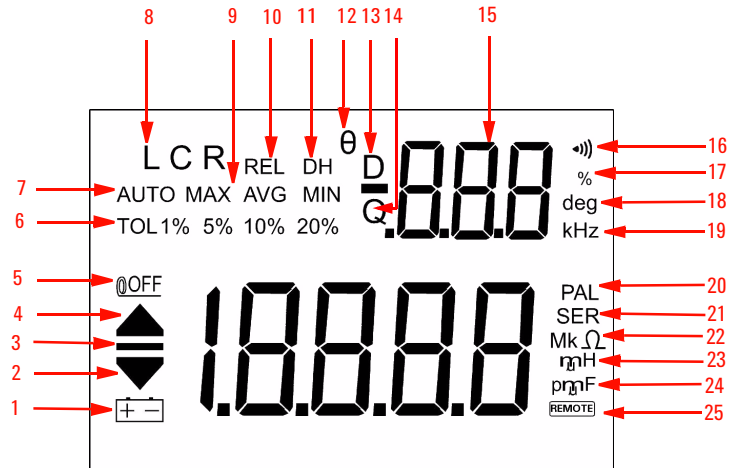

**Figure 1-2** LCD display

**Table 1-1** Descriptions of each annunciator

No.	Symbols	Descriptions
1	$\boxed{+ -}$	Low battery indicator
2	$\blacktriangledown$	Reading out of LO limit
3	-18888	Primary display
4	$\blacktriangle$	Reading out of HI limit
5	@OFF	Auto power off indicator
6	TOL 1% 5% 10% 20%	Tolerance mode, to set 1%, 5%, 10%, and 20% for sorting capacitance
7	AUTO	AUTO range
8	C	Inductance, Capacitance, or Resistance (L,C, or R) function indicator

9	<b>MAX AVG MIN</b>	Static recording mode <b>MAX</b> : Maximum reading <b>AVG</b> : Average reading <b>MIN</b> : Minimum reading
10	<b>REL</b>	Relative mode
11	<b>DH</b>	Data hold to hold the displayed digital value
12	$\theta$	Phase angle indicator (only applicable for U1732B)
13	<b>D</b>	Dissipation factor indicator
14	<b>Q</b>	Quality factor indicator
15		Secondary display
16		Audible alert for tolerance and compare mode
17	%	Unit for tolerance display (percentage)
18	<b>deg</b>	Unit for phase angle (degree) (only applicable for U1732B)
19	<b>kHz</b>	Unit for beeper frequency as setup mode
20	<b>PAL</b>	Parallel mode indicator
21	<b>SER</b>	Series mode indicator
22	<b>mk<math>\Omega</math></b>	Unit for resistance (k $\Omega$ and M $\Omega$ )
23	<b>mH</b>	Unit for inductance ( $\mu$ H and mH)
24	<b>p<math>\mu</math>F</b>	Unit for capacitance (pF, nF, $\mu$ F, and mF)
25		Remote control

## Special indication characters

	Descriptions		Descriptions
	Indicates short connectors		Indicates calibration mode
	Indicates open connectors		Indicates damaged or open fuse

## The Keypad at a Glance

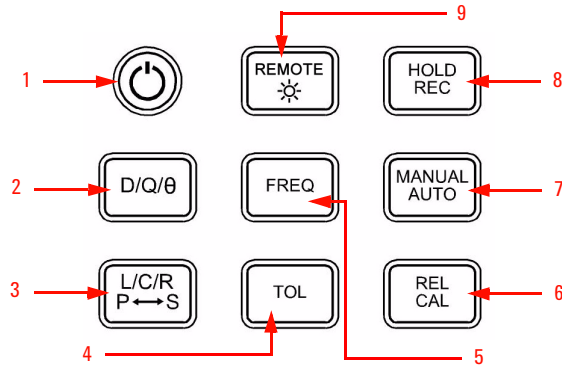

**Figure 1-3** Keypad of U1731B/U1732B dual display handheld LCR meter

**Table 1-2** Keypad descriptions and functions

No.	Keys	Functions
1	Power	To turn ON/OFF the instrument
2	D/Q/θ	To select dissipation factor, quality factor, and phase angle display (only applicable for U1732B)
3	L/C/R P↔S	To select inductance, capacitance, and resistance measurement To toggle parallel and series mode
4	TOL	Tolerance mode
5	FREQ	To select test frequency
6	REL CAL	Relative mode Calibration mode
7	Manual AUTO	Manual range Auto range
8	HOLD REC	Data hold Static recording mode
9	REMOTE ☀	To toggle ON/OFF the remote function Backlight display (only applicable for U1732B)

## The Input Terminal at a Glance

**WARNING**

To avoid damaging this instrument, do not exceed the input limit. Do not apply voltage to input terminals. Discharge the capacitor before testing.

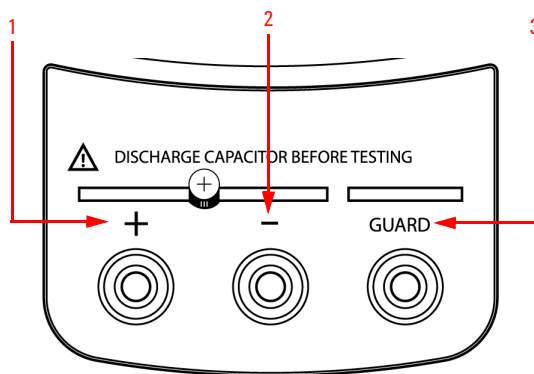

**Figure 1-4** Input terminals/sockets of U1731B/U1732B dual display handheld LCR meter

No.	Terminals	Functions
1	+	Positive terminal/socket
2	-	Negative terminal/socket
3	GUARD	Guard terminal/socket



## 2 Features and Functions

Inductance Measurement	10
Resistance Measurement	12
Data Hold	13
Static Recording	13
Dissipation Factor/Quality Factor/Phase Angle	13
Test Frequency	14
LCR Function Selector	14
Relative	14
Tolerance	15
Auto/Manual Range	15
Automatic Fuse Detection	16
Parallel/Series Mode	16
Calibration	17
Enable/Disable Auto Power-Off	18
Low Battery Indication	18
Backlit Display (Only Available for U1732B)	18
Communication (Optional Accessories)	19

This chapters provides detailed information on the features and functions that are available in the U1731B/U1732B dual display handheld LCR meter.

## Inductance Measurement

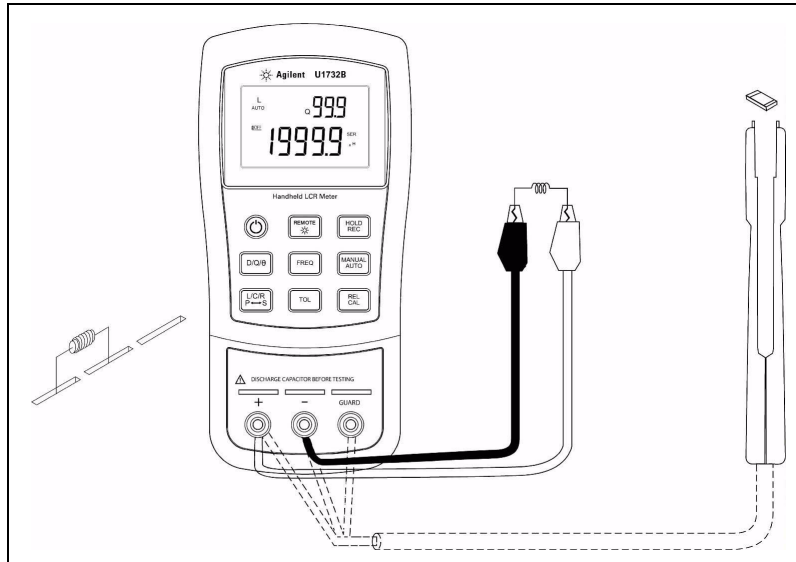

**Figure 2-1** Inductance measurement

- 1 Press the  key to power-on the LCR meter.
- 2 Press the **L/C/R** key to select inductance (L) measurement.
- 3 Insert an inductor into component receptacle socket or connect the test clip to the component leads as required.
- 4 Press the **FREQ** key to select testing frequency.
- 5 Press the **D/Q** or **D/Q/θ** key to select Q factor for secondary display.
- 6 Read the display readings for inductance value and quality factor.

**NOTE**

It is recommended that you calibrate the LCR meter before testing to achieve optimum precision for all **L**, **C**, and **R** measurements at either the highest or lowest ranges.

**WARNING**

To avoid electrical hazards, discharge the capacitor to be tested before measuring.

## Capacitance Measurement

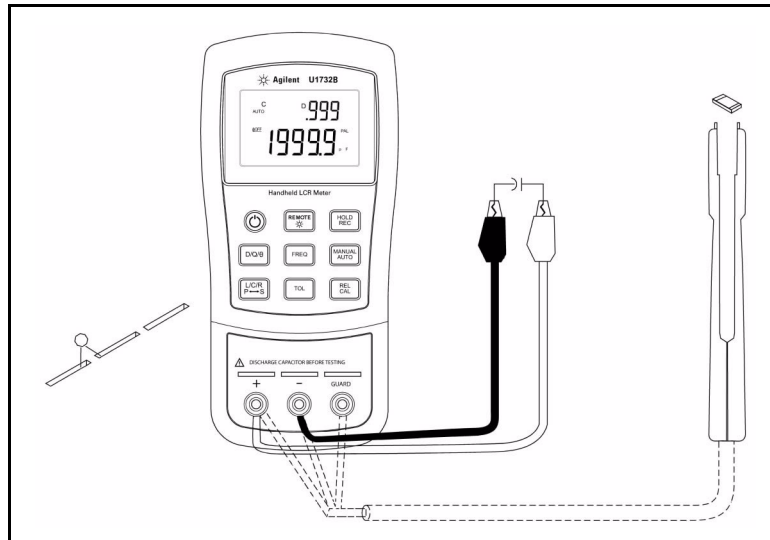

**Figure 2-2** Capacitance measurement

- 1 Press the  key to turn on the LCR meter.
- 2 Press the **L/C/R** key to select capacitance (C) measurement.
- 3 Insert a capacitor into the component receptacle socket or connect the test clip to the component leads as required.
- 4 Press the **FREQ** key to select testing frequency.
- 5 Press the **D/Q** or **D/Q/θ** key to select D factor for secondary display.
- 6 Read the display readings for capacitance value and dissipation factor.

## Resistance Measurement

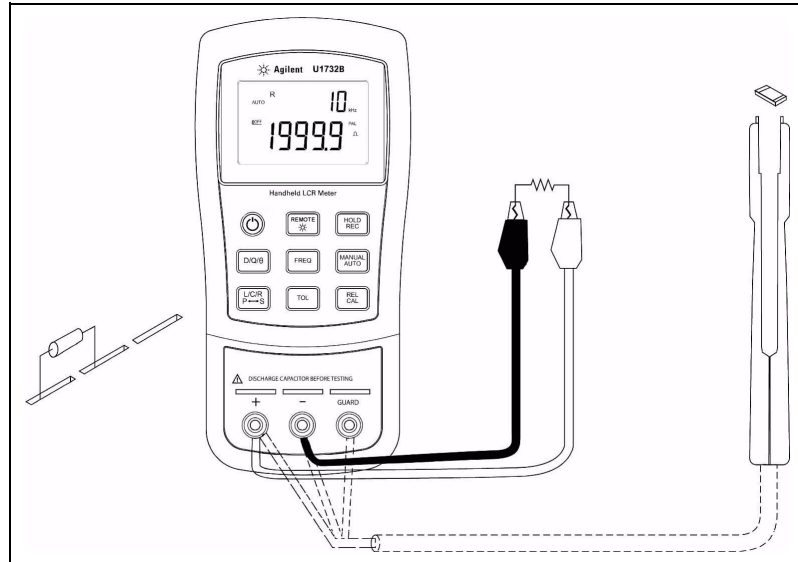

**Figure 2-3** Resistance measurement

- 1 Press the  key to turn on the LCR meter.
- 2 Press the **L/C/R** key to select Resistance measurement.
- 3 Insert a resistor into the component receptacle socket or connect the test clip to the component leads as required.
- 4 Press the **FREQ** key to select testing frequency.
- 5 Read the display readings for resistance value.



## Data Hold

The data-hold function allows the user to freeze the display. To enter this mode, press the **HOLD** key. Press the key again to release.

## Static Recording

Press the **REC** key for more than one second to enter the static recording mode. The maximum and minimum readings are then stored in memory. The beeper will beep once when a new reading has been recorded. Press the same key to cycle through the maximum, minimum, and average of the present readings.

The **MAX**, **MIN**, or **AVG** annunciator will appear on the display to indicate which value is being displayed. Whenever the **MAX** **AVG** **MIN** annunciators appear on the display simultaneously, the display reading is always a present value.

To exit this mode, press and hold the key for more than one second.

### NOTE

- 1 Static recording captures only stable values and updates the memory; it will not record any overload (OL) value for any of the LCR functions. In addition, the LCR meter will not record values below 50 counts in capacitance measurement.
- 2 Static recording is only available in manual ranging; however, activation while in auto-ranging will automatically set the LCR meter to manual ranging and cause calibration prompts to be displayed in the recommended ranges.

## Dissipation Factor/Quality Factor/Phase Angle

The **D/Q/  $\theta$**  values can be displayed interchangeably by pressing the **D/Q/  $\theta$**  key when the LCR meter is set to inductance or capacitance mode. This setting does not apply to resistance measurement. The phase angle mode ( $\theta$ ) is only available for the U1732B.

### Test Frequency

The testing frequency is set to 1 kHz by default. Press the **FREQ** key to select the desired test frequency.

### LCR Function Selector

Press the **L/C/R** key to select the L, C, or R function as desired.

### Relative

Press the **REL** key to enter the relative mode and store the display reading as a reference value. It will then display all subsequent readings relative to reference value. Press the key again to exit the relative mode.

#### NOTE

- 1 The relative mode cannot be activated if the display value is either "OL" or "0000".
  - 2 Relative mode is only available in manual ranging; however, activation while in auto-ranging will automatically set the LCR meter to manual ranging and cause calibration prompts to be displayed in the recommended ranges.
  - 3 The relative mode cannot be activated if the LCR meter is set at auto-ranging with data hold activated.
-

## Tolerance

The tolerance ranges available are 1%, 5%, 10%, and 20%. To enter tolerance mode, insert the appropriate component as a standard value into the socket or connect the component to the test probes, then press the **TOL** key to set this value, as the standard reference tolerance. Similarly, any value which appears on the display, such as **DH** or **MAX/MIN/AVG**, can be used as a standard value to sort components. Press this key again to cycle through 1%, 5%, 10% and 20% tolerance as desired.

This function is designed for convenient component sorting. The beeper will beep three times whenever the component under test exceeds the setting tolerance. Conversely, when the beeper beeps once, this indicates that the component is within the setting tolerance.

### NOTE

- 1 The tolerance mode cannot be activated if "OL" or "0000" is shown on the display or when the tested capacitance value is below 10 counts.
- 2 Tolerance mode is only available in manual ranging; however, activation while in auto-ranging will automatically set the LCR meter to manual ranging and cause calibration prompts to be displayed in the recommended ranges.
- 3 The tolerance mode cannot be activated if the LCR meter is set to auto-ranging with data hold mode activated.
- 4 The 20% tolerance selection is only available for U1732B.

## Auto/Manual Range

The LCR meter is set to auto-ranging mode by default when the meter is powered-on. For specific measurement, press **AUTO/MANUAL** key to select manual ranging. To return to the auto-ranging mode, press and hold the **AUTO/MANUAL** key for more than one second.

### Automatic Fuse Detection

When the LCR meter detects that the protective fuse is open or damaged, the **FUSE** character (as shown in [Figure 2-4](#)) will appear on the display and the beeper will beep continuously. In this situation, none of the function keys can be operated and all other LCR meter functions will be discontinued. Fuse replacement is required. To replace protective fuse, refer to [Chapter 3](#), “Fuse Replacement”.



**Figure 2-4** Fuse detection

### Parallel/Series Mode

The LCR meter can display parallel (PAL) and series (SER) mode data for all ranges. For capacitance and resistance measurements, the LCR meter is set to parallel mode by default. Series mode is the default setting for inductance measurement. Press the **L/C/R** key for more than one second to toggle **PAL** and **SER** mode.

## Calibration

The calibration function is available for all measurement ranges. Press and hold the **CAL** key for more than one second to enter calibration mode. Calibration prompts will be shown on the display. Follow the prompts for open connector (OPn) or short connector (Srt) connection and press the **CAL** key. After calibration is completed, the LCR meter will be restored to normal display and ready for normal usage.

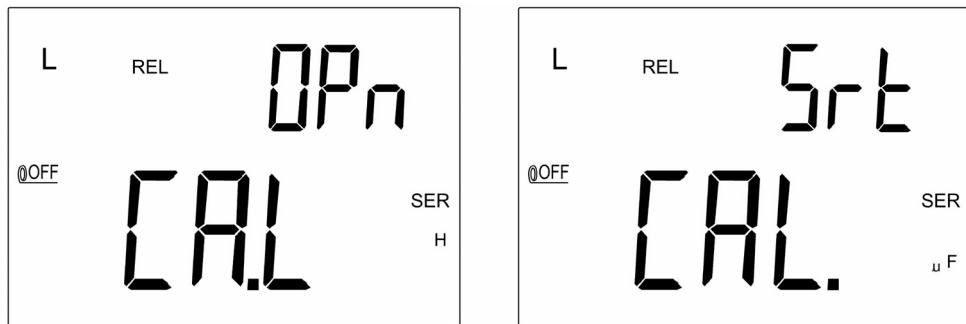

**Figure 2-5** Open calibration and short calibration

This function enables the LCR meter's internal parameters and external connector residues to be calibrated to achieve more precise measurements. It is highly recommended that you calibrate extremely high or low ranges for **L**, **C**, and **R** before making precision measurements. Calibration prompts will be displayed automatically every time these ranges are manually or functionally selected, (e.g. **REL**, **TOL**, **REC**, etc.) and therefore calibration is recommended. Follow the open connector (OPn) or short connector (Srt) instruction shown on the display and then press the **CAL** key. To skip the calibration process, press the **D/Q** or **D/Q/θ** key.

### NOTE

- 1 Changing measurement frequencies is handled the same way as selecting a different hardware range, and the automatic calibration prompts will be displayed in the recommended ranges.
- 2 Ensure that the same testing position is used after short calibration.

### Enable/Disable Auto Power-Off

When the LCR meter has not been used for five minutes since the last operation, the beeper will beep a long tone. Then the LCR meter will automatically enter sleep mode and none of the annunciators will shown on the display. To re-activate the LCR meter, press any key.

When the LCR meter must be used for a longer period, the auto power-off function can be disabled. To disable auto power-off, press and hold the **L/C/R** key while turning LCR meter ON. Release the **L/C/R** key and press any key again. The **@OFF** annunciator will disappear. This will confirm that the auto power-off function has been disabled.

When a 12 VAC adaptor is used as an optional power source, the auto power-off function is automatically disabled.

#### NOTE

It is recommended that the LCR meter should always be powered off when not in use.

### Low Battery Indication

When the  annunciator is blinking on the display, this shows that the battery voltage is below normal working voltage and is weakening. Replace the battery with a new battery to maintain the precision of the LCR meter. To replace the battery, refer to [Chapter 3](#), “Battery Replacement”.

### Backlit Display (Only Available for U1732B)

Press and the hold  key for more than one second to toggle backlit ON/OFF. This function is only available for the U1732B.

## Communication (Optional Accessories)

The LCR meter can be adapted for communication capability. The optional IR-USB package come with full optical isolated cable and software. This function enables the user to record data easily. Refer to the following procedures to set up the communication between your LCR meter and personal computer (PC).

- 1 Connect one side of the cable to the meter with the Agilent logo facing up and connect the USB connector to the PC.
- 2 Press the **REMOTE** key to enable this interface; the **REMOTE** annunciator will be shown on the display.
- 3 Run the Data Logger software to transfer the data to the PC for your applications.
- 4 To remove the cable, press and pull the snap ends on each side of the cable that is connected to the meter.

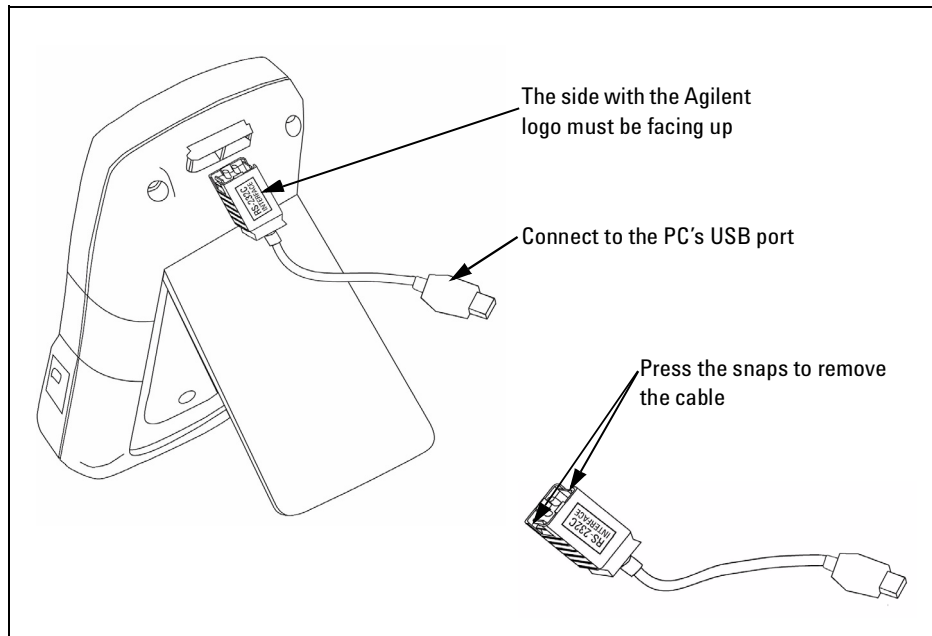

**Figure 2-6** Cable connection for remote communication

## 2 Features and Functions





## 3 Service and Maintenance

Service	22
Battery Replacement	22
Fuse Replacement	24
Replacement Parts	25
Cleaning the LCR Meter	26
Specification Validation	27

This chapter describes the service and maintenance procedures for the U1731B/U1732B dual display handheld LCR meter. Repair or service that are not covered in this manual should only be performed by qualified personnel.



## Service

### WARNING

To avoid electrical shock, do not perform any service unless you are qualified to do so.

---

If the instrument fails to operate, check the battery and test leads. Replace the battery or test leads if necessary. If the instrument still cannot function, check again the operating procedures described in this instruction manual. When servicing, use specified replacement parts only. The LCR meter must be completely turned off while replacing either the fuse or battery.

## Battery Replacement

### WARNING

Do not discharge the battery by shorting the battery or reversing the battery polarity.

---

The LCR meter is powered by a single 9 V alkaline battery. Replace the battery if the low battery sign (  ) is displayed and flashing. Use the following procedures to replace the battery.

- 1 Loosen screws with a suitable screwdriver and remove the battery cover as shown in [Figure 3-1](#).
- 2 Replace the degraded battery with a new battery.

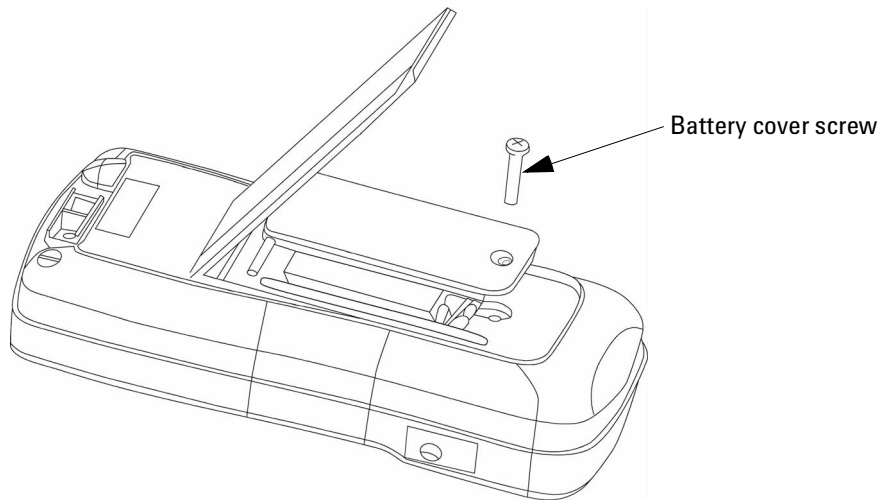

**Figure 3-1** Battery replacement

## Fuse Replacement

**NOTE**

Users should use clean/dry gloves when performing fuse replacement. Do not touch any components except the fuse and plastic parts. No recalibration is required after replacing the fuse.

The LCR meter is able to self-detect if the input protective fuse is either open or damaged. In this case, the display will show **FUSE** and beep will sound continuously, warning the user to replace the damaged fuse to maintain the accuracy of measurement. While replacing the fuse, the LCR meter must be completely turned off.

- 1 Loosen screws with a suitable screwdriver and remove the battery cover as shown in [Figure 3-1](#).
- 2 Loosen screws with a suitable screwdriver and remove the bottom cover as shown in [Figure 3-2](#).
- 3 Replace the damaged fuse with the a new fuse as specified in [Chapter 4](#), “General Specifications”.

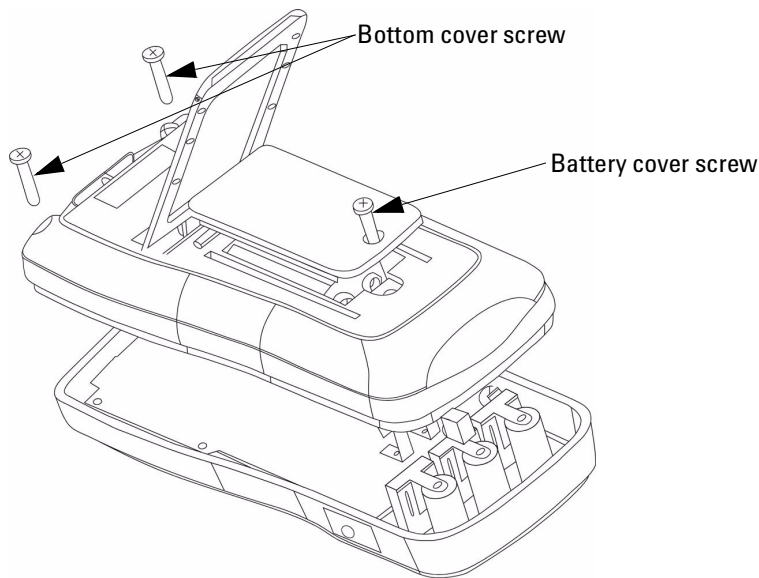

**Figure 3-2** Fuse replacement

## Replacement Parts

This section explains how to order replacement parts for your instrument.

### To order replaceable parts

You can order replaceable parts from Agilent using the Agilent part number. Note that not all parts listed in this chapter are available as field-replaceable parts. To order replaceable parts from Agilent, do the following.

- 1 Contact your nearest Agilent sales office or service center.
- 2 Identify the parts by the Agilent part number shown in the replaceable parts list.
- 3 Provide the instrument model number and serial number.

**Table 3-1** Replaceable parts

Part Number	Description
A02-62-25612-2U	Fuse

## Cleaning the LCR Meter

**WARNING**

To avoid electrical shock or damage to the LCR meter, never contact with water inside the case.

---

Before cleaning the LCR meter, ensure that the LCR meter's power is completely turned off and remove the external DC adaptor. To clean the LCR meter, wipe the dirty parts with gauze or soft cloth soaked mildly in diluted neutral detergent. After cleaning, ensure that the instrument is completely dried before using.

## Specification Validation

You can perform self-validation of the LCR meter's accuracy by using the recommended equipment with the specified test ranges below.

**Table 3-1** Resistance ranges for functional validation

**Resistance (Parallel Mode), Test Frequency: 100 Hz, 120 Hz, 1000 Hz, or 10 kHz**

Recommended Equipment: IET 1433 Resistor Box	
Range ( $\Omega$ )	Test Value Used
200 k	100 k
2000	1000
20	10

**Table 3-2** Capacitance ranges for functional validation

**Capacitance (Parallel Mode), Test Frequency: 100 Hz, 120 Hz, 1000 Hz, or 10 kHz**

Recommended Equipment: HACS-Z Precision Decade Capacitor	
Range (F)	Test Value Used
20 $\mu$	10 $\mu$
200 n	100 n
20 n	10 n
200 p*	100 p

\* Does not support test frequency of 100 Hz, 120 Hz, and 1000 Hz

### 3 Service and Maintenance

**Table 3-3** Inductance ranges for functional validation

**Inductance (Series Mode), Test Frequency: 100 Hz, 120 Hz, 1000 Hz, or 10 kHz**

<b>Recommended Equipment: GR1491 Precision Decade Inductor</b>	
<b>Range (H)</b>	<b>Test Value Used</b>
200 m	100 m
20 m	10 m
2000 $\mu$ *	1000 $\mu$

\* Does not support test frequency of 100 Hz and 120 Hz



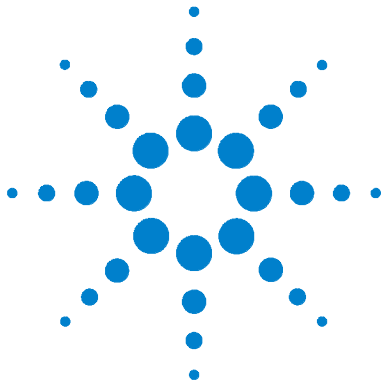

## 4 Specifications

U1731B Electrical Specifications 30

U1732B Electrical Specifications 33

General Specifications 37

SMD Tweezers Specifications 39

This chapter contains the U1731B/U1732B dual display handheld LCR meter's electrical and general specifications.



## U1731B Electrical Specifications

Accuracy is expressed as  $\pm$  (% of reading + number of least significant digits) at 23 °C  $\pm$  5 °C and <75% R.H.

### Resistance (Parallel Mode), Test Frequency =120 Hz/1 kHz

Range	Maximum Display	Accuracy		Specified Note
		@ 120 Hz	@ 1 kHz	
10 M $\Omega$	9.999 M $\Omega$	2.0% + 8 <sup>1</sup>	2.0% + 8 <sup>1</sup>	After open cal.
2000 K $\Omega$	1999.9 K $\Omega$	0.5% + 5	0.5% + 5	After open cal.
200 K $\Omega$	199.99 K $\Omega$	0.5% + 3	0.5% + 3	-
20 K $\Omega$	19.999 K $\Omega$	0.5% + 3	0.5% + 3	-
2000 $\Omega$	1999.9 $\Omega$	0.5% + 3	0.5% + 3	-
200 $\Omega$	199.99 $\Omega$	0.8% + 5	0.8% + 5	After short cal.
20 $\Omega$	19.999 $\Omega$	1.2% + 40	1.2% + 40	After short cal.

1 This specification is based on the battery operation.

### NOTE

- 1 This specification is based on the measurement performed at the test socket.
- 2 Device Under Test (DUT) and test leads need to be properly shielded to GUARD if necessary.

### Capacitance (Parallel Mode), Test Frequency =120 Hz

Range	Maximum Display	Accuracy		Specified Note
		Capacitance	DF	
10 mF	19.99 mF <sup>1</sup>	3.0% +5 (DF<0.1)	10% + 100/Cx + 5 (DF<0.1)	After short cal.
1000 $\mu$ F	1999.9 $\mu$ F <sup>2</sup>	1.0% + 5 (DF<0.1)	2.0% + 100/Cx + 5 (DF<0.1)	After short cal.
200 $\mu$ F	199.99 $\mu$ F	0.7% + 3 (DF<0.5)	0.7% + 100/Cx + 5 (DF<0.5)	-
20 $\mu$ F	19.999 $\mu$ F	0.7% + 3 (DF<0.5)	0.7% + 100/Cx + 5 (DF<0.5)	-
2000 nF	1999.9 nF	0.7% + 3 (DF<0.5)	0.7% + 100/Cx + 5 (DF<0.5)	-
200 nF	199.99 nF	0.7% + 5 (DF<0.5)	0.7% + 100/Cx + 5 (DF<0.5)	After open cal.
20 nF	19.999 pF	1.0% + 5 (DF<0.1)	2.0% + 100/Cx + 5 (DF<0.1)	After open cal.

1 This reading can be extended up to 1999 MAX display with accuracy that is not specified.

2 This reading can be extended up to 19999 MAX display with accuracy that is not specified.

### Capacitance (Parallel Mode), Test Frequency =1 kHz

Range	Maximum Display	Accuracy		Specified Note
		Capacitance	DF	
1 mF	1.999 mF <sup>1</sup>	3.0% + 5 (DF<0.1)	10.0% + 100/Cx +5 (DF<0.1)	After short cal.
200 μF	199.99 μF	1.0% + 5 (DF<0.1)	2.0%+ 100/Cx +5 (DF<0.1)	After short cal.
20 μF	19.999 μF	0.7% + 3 (DF<0.5)	0.7% + 100/Cx +5 (DF<0.5)	-
2000 nF	1999.9 μF	0.7% + 3 (DF<0.5)	0.7% + 100/Cx +5 (DF<0.5)	-
200 nF	199.99 nF	0.7% + 3 (DF<0.5)	0.7% + 100/Cx +5 (DF<0.5)	-
20 nF	19.999 nF	0.7% + 5 (DF<0.5)	0.7% + 100/Cx +5 (DF<0.5)	After open cal.
2000 pF	1999.9 pF	1.0% + 5 (DF<0.1)	2.0% + 100/Cx +5 (DF<0.1)	After open cal.

1 This reading can be extended up to 1999 MAX display with accuracy that is not specified.

#### NOTE

- 1 Q value is the reciprocal of DF.
- 2 This specification is based on the measurement performed at the test socket.
- 3 Device Under Test (DUT) and test leads need to be properly shielded to GUARD if necessary.
- 4 Cx = Counts of displayed C value, e.g. C = 88.88 μF then Cx = 8888.

### Inductance (Series Mode), Test Frequency =120 Hz

Range	Maximum Display	Accuracy		Specified Note
		Inductance	DF	
1000 H	999.9 H	1.0% + (Lx/10000)% +5	2.0% + 100/Lx + 5	After open cal.
200 H	199.99 H	0.7% + (Lx/10000)% +5	1.2% + 100/Lx + 5	-
20 H	19.999 H	0.7% + (Lx/10000)% +5	1.2% + 100/Lx + 5	-
2000 mH	1999.9 mH	0.7% + (Lx/10000)% +5	1.2% + 100/Lx + 5	-
200 mH	199.99 mH	1.0% + (Lx/10000)% +5	3.0% + 100/Lx + 5	After short cal.
20 mH	19.999 mH	2.0% + (Lx/10000)% +5	10.0% + 100/Lx + 5	After short cal.

## 4 Specifications

### Inductance (Series Mode), Test Frequency =1 kHz

Range	Maximum Display	Accuracy		Specified Note
		Inductance	DF	
100 H	99.99 H	$1.0\% + (L_x/10000)\% + 5$	$2.0\% + 100/L_x + 5$	After open cal.
20 H	19.999 H	$0.7\% + (L_x/10000)\% + 5$	$1.2\% + 100/L_x + 5$	-
2000 mH	1999.9 mH	$0.7\% + (L_x/10000)\% + 5$	$1.2\% + 100/L_x + 5$	-
200 mH	199.99 mH	$0.7\% + (L_x/10000)\% + 5$	$1.2\% + 100/L_x + 5$	-
20 mH	19.999 mH	$1.0\% + (L_x/10000)\% + 5$	$3.0\% + 100/L_x + 5$	After short cal.
2000 $\mu$ H	1999.9 $\mu$ H	$2.0\% + (L_x/10000)\% + 5$	$10.0\% + 100/L_x + 5$	After short cal.

#### NOTE

- 1 Q value is the reciprocal of DF.
- 2 This specification is based on the measurement performed at the test socket.
- 3 Device Under Test (DUT) and test leads need to be properly shielded to GUARD if necessary.
- 4  $L_x$  = Counts of displayed L value, e.g.  $L = 88.88$  H then  $L_x = 8888$ .

## U1732B Electrical Specifications

Accuracy is expressed as  $\pm$  (% of reading + number of least significant digits) at 23 °C  $\pm$  5 °C and <75% R.H.

### Resistance (Parallel Mode), Test Frequency = 100 Hz/120 Hz

Range	Maximum Display	Accuracy		Specified Note
		@ 100 Hz	@ 120 Hz	
10 M $\Omega$	9.999 M $\Omega$	2.0% + 8 <sup>1</sup>	2.0% + 8 <sup>1</sup>	After open cal.
2000 k $\Omega$	1999.9 k $\Omega$	0.5% + 5	0.5% + 5	After open cal.
200 k $\Omega$	199.99 k $\Omega$	0.5% + 3	0.5% + 3	-
20 k $\Omega$	19.999 k $\Omega$	0.5% + 3	0.5% + 3	-
2000 $\Omega$	1999.9 $\Omega$	0.5% + 3	0.5% + 3	-
200 $\Omega$	199.99 $\Omega$	0.8% + 5	0.8% + 5	After short cal.
20 $\Omega$	19.999 $\Omega$	1.2% + 40	1.2% + 40	After short cal.

1 This specification is based on the battery operation.

### Resistance (Parallel Mode), Test Frequency = 1 kHz/10 kHz

Range	Maximum Display	Accuracy		Specified Note
		@ 1 kHz	@ 10 kHz	
10 M $\Omega$	9.999 M $\Omega$	2.0% + 8 <sup>1</sup>	3.5% + 10 <sup>1</sup>	After open cal.
2000 k $\Omega$	1999.9 k $\Omega$	0.5% + 5	2.0% + 10	After open cal.
200 k $\Omega$	199.99 k $\Omega$	0.5% + 3	1.5% + 5	-
20 k $\Omega$	19.999 k $\Omega$	0.5% + 3	1.5% + 5	-
2000 $\Omega$	1999.9 $\Omega$	0.5% + 3	1.5% + 5	-
200 $\Omega$	199.99 $\Omega$	0.8% + 5	2.0% + 10	After short cal.
20 $\Omega$	19.999 $\Omega$	1.2% + 40	2.5% + 200	After short cal.

1 This specification is based on the battery operation.

#### NOTE

- 1 This specification is based on the measurement performed at the test socket.
- 2 Device Under Test (DUT) & test leads needs to be properly shielded to GUARD if necessary.

## 4 Specifications

### Capacitance (Parallel Mode), Test Frequency = 100 Hz/120 Hz

Range	Maximum Display	Accuracy		Specified Note
		Capacitance	DF	
10 mF	19.99 mF <sup>1</sup>	3.0% + 5 (DF<0.1)	10.0% + 100/Cx + 5 (DF<0.1)	After short cal.
1000 μF	1999.9 μF <sup>2</sup>	1.0% + 5 (DF<0.1)	2.0% + 100/Cx + 5 (DF<0.1)	After short cal.
200 μF	199.99 μF	0.7% + 3 (DF<0.5)	0.7% + 100/Cx + 5 (DF<0.5)	-
20 μF	19.999 μF	0.7% + 3 (DF<0.5)	0.7% + 100/Cx + 5 (DF<0.5)	-
2000 nF	1999.9 nF	0.7% + 3 (DF<0.5)	0.7% + 100/Cx + 5 (DF<0.5)	-
200 nF	199.99 nF	0.7% + 5 (DF<0.5)	0.7% + 100/Cx + 5 (DF<0.5)	After open cal.
20 nF	19.999 nF	1.0% + 5 (DF<0.1)	2.0% + 100/Cx + 5 (DF<0.1)	After open cal.

- 1 This reading can be extended up to 1999 MAX display with accuracy that is not specified.
- 2 This reading can be extended up to 19999 MAX display with accuracy that is not specified.

### Capacitance (Parallel Mode), Test Frequency = 1 kHz

Range	Maximum Display	Accuracy		Specified Note
		Capacitance	DF	
1 mF	1.999 mF <sup>1</sup>	3.0% + 5 (DF<0.1)	10% + 100/Cx + 5 (DF<0.1)	After short cal.
200 μF	199.99 μF	1.0% + 5 (DF<0.1)	2.0% + 100/Cx + 5 (DF<0.1)	After short cal.
20 μF	19.999 μF	0.7% + 3 (DF<0.5)	0.7% + 100/Cx + 5 (DF<0.5)	-
2000 nF	1999.9 nF	0.7% + 3 (DF<0.5)	0.7% + 100/Cx + 5 (DF<0.5)	-
200 nF	199.99 nF	0.7% + 3 (DF<0.5)	0.7% + 100/Cx + 5 (DF<0.5)	-
20 nF	19.999 nF	0.7% + 5 (DF<0.5)	0.7% + 100/Cx + 5 (DF<0.5)	After open cal.
2000 pF	1999.9 pF	1.0% + 5 (DF<0.1)	2.0% + 100/Cx + 5 (DF<0.1)	After open cal.

- 1 This reading can be extended up to 1999 MAX display with accuracy that is not specified.

### Capacitance (Parallel Mode), Test Frequency = 10 kHz

Range	Maximum Display	Accuracy		Specified Note
		Capacitance	DF	
50 $\mu$ F	50.0 $\mu$ F	3.0% + 8 (DF<0.1)	12.0% + 100/Cx + 10 (DF<0.1)	After short cal.
20 $\mu$ F	19.999 $\mu$ F	3.0% + 6 (DF<0.2)	5.0% + 100/Cx + 8 (DF<0.2)	After short cal.
2000 nF	1999.9 nF	1.5% + 5 (DF<0.5)	1.5% + 100/Cx + 6 (DF<0.5)	-
200 nF	199.99 nF	1.5% + 5 (DF<0.5)	1.5% + 100/Cx + 6 (DF<0.5)	-
20 nF	19.999 nF	1.5% + 5 (DF<0.5)	1.5% + 100/Cx + 6 (DF<0.5)	-
2000 pF	1999.9 pF	2.0% + 6 (DF<0.5)	3.0% + 100/Cx + 6 (DF<0.1)	After open cal.
200pF	199.99 pF	3.0% + 8 (DF<0.1)	5.0% + 100/Cx + 8 (DF<0.1)	After open cal.

#### NOTE

- 1 Q value is the reciprocal of DF.
- 2 This specification is based on the measurement performed at the test socket.
- 3 Device Under Test (DUT) and test leads need to be properly shielded to GUARD if necessary.
- 4 Cx = Counts of displayed C value, e.g. C = 88.88  $\mu$ F then Cx = 8888.

### Inductance (Series mode), Test Frequency = 100 Hz/120 Hz

Range	Maximum Display	Accuracy		Specified Note
		Inductance	DF	
1000 H	999.9 H	1.0% + (Lx/10000)% + 5	2.0% + 100/Lx + 5	After open cal.
200 H	199.99 H	0.7% + (Lx/10000)% + 5	1.2% + 100/Lx + 5	-
20 H	19.999 H	0.7% + (Lx/10000)% + 5	1.2% + 100/Lx + 5	-
2000 mH	1999.9 mH	0.7% + (Lx/10000)% + 5	1.2% + 100/Lx + 5	-
200 mH	199.99 mH	1.0% + (Lx/10000)% + 5	3.0% + 100/Lx + 5	After short cal.
20 mH	19.999 mH	2.0% + (Lx/10000)% + 5	10.0% + 100/Lx + 5	After short cal.

## 4 Specifications

### Inductance (Series Mode), Test Frequency = 1 kHz

Range	Maximum Display	Accuracy		Specified Note
		Inductance	DF	
100 H	99.99 H	$1.0\% + (Lx/10000)\% + 5$	$2.0\% + 100/Lx + 5$	After open cal.
20 H	19.999 H	$0.7\% + (Lx/10000)\% + 5$	$1.2\% + 100/Lx + 5$	-
2000 mH	1999.9 mH	$0.7\% + (Lx/10000)\% + 5$	$1.2\% + 100/Lx + 5$	-
200 mH	199.99 mH	$0.7\% + (Lx/10000)\% + 5$	$1.2\% + 100/Lx + 5$	-
20 mH	19.999 mH	$1.0\% + (Lx/10000)\% + 5$	$3.0\% + 100/Lx + 5$	After short cal.
2000 $\mu$ H	1999.9 $\mu$ H	$2.0\% + (Lx/10000)\% + 5$	$10.0\% + 100/Lx + 5$	After short cal.

### Inductance (Series Mode), Test Frequency = 10 kHz

Range	Maximum Display	Accuracy		Specified Note
		Inductance	DF	
1000 mH	999.9 mH	$2.0\% + (Lx/10000)\% + 8$	$2.0\% + 100/Lx + 10$	-
200 mH	199.99 mH	$1.5\% + (Lx/10000)\% + 8$	$2.0\% + 100/Lx + 10$	-
20 mH	19.999 mH	$1.5\% + (Lx/10000)\% + 10$	$3.0\% + 100/Lx + 15$	-
2000 $\mu$ H	1999.9 $\mu$ H	$2.0\% + (Lx/10000)\% + 10$	$8.0\% + 100/Lx + 20$	After short cal.

#### NOTE

- 1 Q value is the reciprocal of DF.
- 2 This specification is based on the measurement performed at the test socket.
- 3 Device Under Test (DUT) & test leads need to be properly shielded to GUARD if necessary.
- 4  $Lx$  = counts of displayed L value, e.g.  $L = 88.88$  H, then  $Lx = 8888$ .



## General Specifications

**Table 4-1** General characteristics of U1731B and U1732B

Parameter	U1731B	U1732B
Power supply	Single standard 9 V battery (Alkaline) External DC adaptor (DC 12 V <sub>MIN</sub> — 15 V <sub>MAX</sub> , Load 50 mA minimum)	
Display	L/C/R: Maximum display 19999 D/Q: Maximum display 999 (Auto Range)	
Measurements	L/C/R/D/Q	L/C/R/D/Q/θ
Measuring circuit mode	Inductance (L): Defaults to series mode Capacitance/Resistance (C/R): Defaults to parallel mode	
Ranging mode	Auto & Manual	
Measuring terminals	Three terminals with sockets	
Tolerance mode	1%, 5%, 10%	1%, 5%, 10%, 20%
Test signal level	~0.6 V <sub>RMS</sub>	
Test frequency accuracy: ±0.1%	120 Hz = 120 Hz 1 kHz = 1010 Hz	100 Hz = 100 Hz 120 Hz = 120 Hz 1 kHz = 1010 Hz 10 kHz = 9.6 kHz
Measuring rate	1 time/s, nominal	
Response time	~1 s/DUT (manual range)	
Auto power-off	~5 mins without operations	
Low battery indicator	~6.8 V	
Operating temperature	0 °C – 40 °C	
Storage temperature	–20 °C – 60 °C (without battery)	
Storage humidity	0 – 80% R.H.	
Relative Humidity (R.H.)	0 – 70% R.H.	
Temperature coefficient	0.15 x (Specified accuracy)/°C (0 °C – 18 °C or 28 °C – 40 °C)	
Battery type	Alkaline: ANSI/NEDA: 1604A/IEC: 6LR61	
Power consumption	~40 mA for operation 0.08 mA after Auto Power-off	
Protective fuse	0.1 A/250 V fuse (Input protective)	
Battery life	5 to 7 hours typical (without backlight based on new alkaline)	

## 4 Specifications

Parameter	U1731B	U1732B
Backlight display	Not available	Available
Weight	330 g	
Dimension (W x L x H)	87 mm x 184 mm x 41 mm	
Safety	Designed in compliance with IEC 61010-1 for Pollution Degree 2	
Warranty	3 years for main unit 3 months for standard accessories unless otherwise specified	

## SMD Tweezers Specifications

The SMD tweezers are used for L/C/R meter and built-in banana input terminals. The SMD tweezers are much more convenient to be used to measure the SMD components.

It is recommended to measure the surface mount device as well as the maximum opening of the tweezers. The tweezers have one red, one black, and one green 4 mm shrouded plugs, which are connected to the meter's +(H-SENSE), -(L-SENSE) and GUARD ends, respectively. The length is approximately 770 mm (30.3) (see [Figure 4-1](#)).

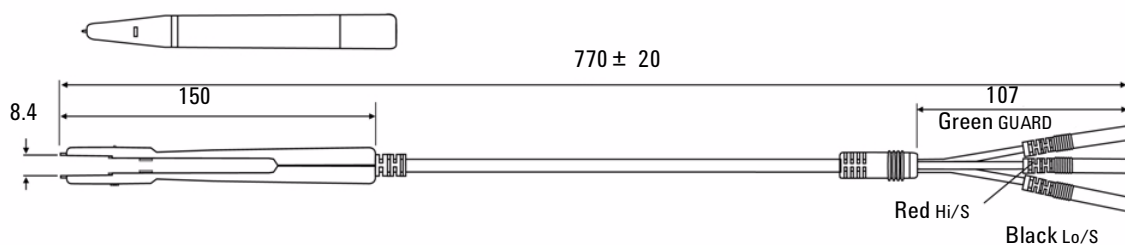

**Figure 4-1** SMD tweezers

## Electrical characteristics

Parameters	Test Condition	100 Hz	120 Hz	1 kHz	10 kHz
<b>Cp</b> Parallel Capacitance	Tweezers Open	<5.0 pF	<5.0 pF	<5.0 pF	<5.0 pF
<b>Rs</b> Series Resistance	Tweezers Short	<0.15 Ω	<0.15 Ω	<0.15 Ω	<0.15 Ω
<b>Ls</b> Series Inductance	Tweezers Short	<1.0 μH	<1.0 μH	<1.0 μH	<1.0 μH

### NOTE

- 1 The specification is specified at 23 °C ±5 °C and <75% R.H.
- 2 The tweezers are recommended to measure the SMD components for C < 200 μF or L < 20 mH or R <10 MΩ.

## Environmental condition

This tweezers is for indoor use at an altitude of up to 2,000 m.

Operation temperature: 0 °C to 50 °C, R.H. 80%.

Storage temperature: -20 °C to 60 °C.

### WARNING

**To avoid electrical shock, never use wet tweezers with your instruments.**

**www.agilent.com**

Contact us

To obtain service, warranty or technical support assistance, contact us at the following phone numbers:

United States:

(tel) 800 829 4444 (fax) 800 829 4433

Canada:

(tel) 877 894 4414 (fax) 800 746 4866

China:

(tel) 800 810 0189 (fax) 800 820 2816

Europe:

(tel) 31 20 547 2111

Japan:

(tel) (81) 426 56 7832 (fax) (81) 426 56 7840

Korea:

(tel) (080) 769 0800 (fax) (080) 769 0900

Latin America:

(tel) (305) 269 7500

Taiwan:

(tel) 0800 047 866 (fax) 0800 286 331

Other Asia Pacific Countries:

(tel) (65) 6375 8100 (fax) (65) 6755 0042

Or visit Agilent worldwide web at:

[www.agilent.com/find/assist](http://www.agilent.com/find/assist)

Product specifications and descriptions in this document subject to change without notice. Always refer to the Agilent Web site for the latest revision.

© Agilent Technologies, Inc. 2009

Printed in Malaysia

First Edition, December 1, 2009

U1731-90059



**Agilent Technologies**